

4

3

2

1

A



B

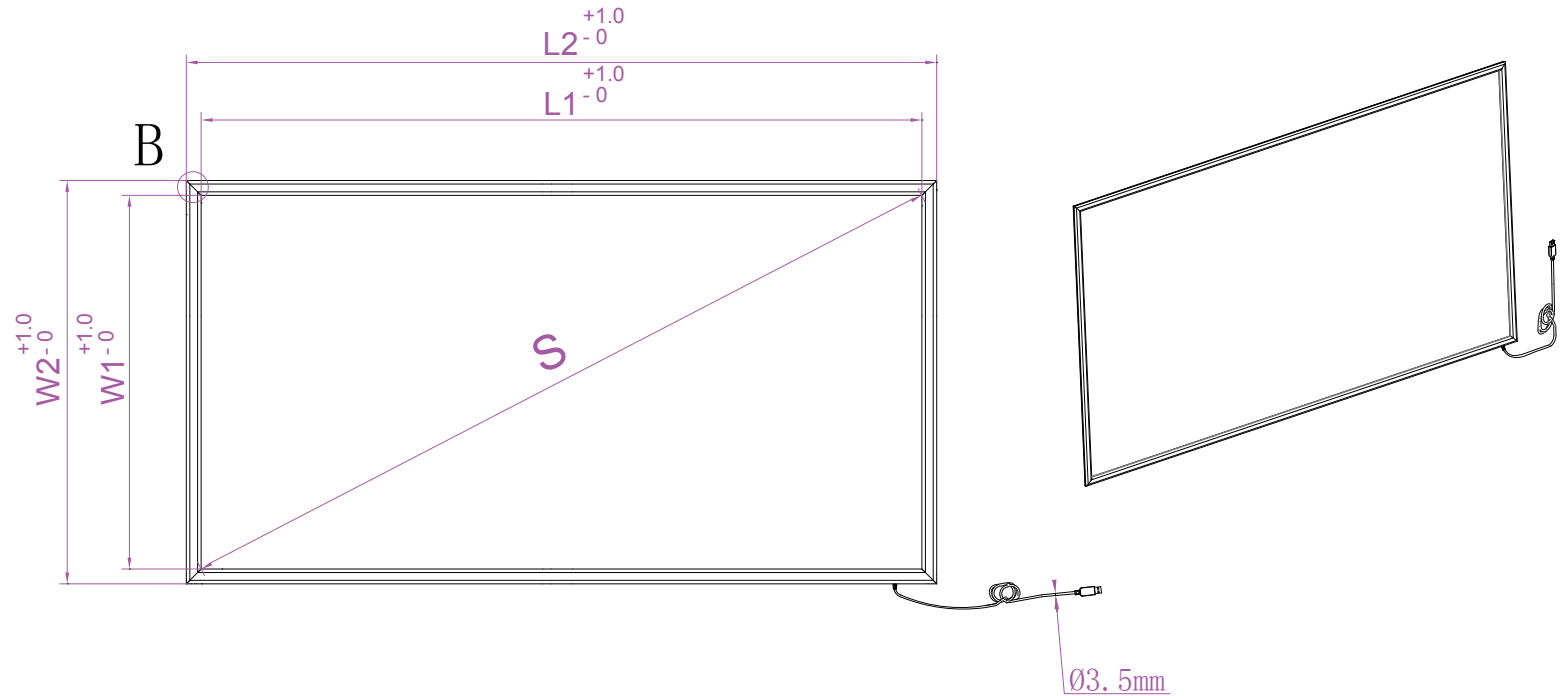

A

B

C

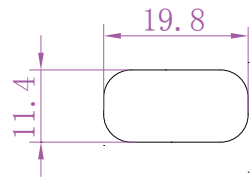

A

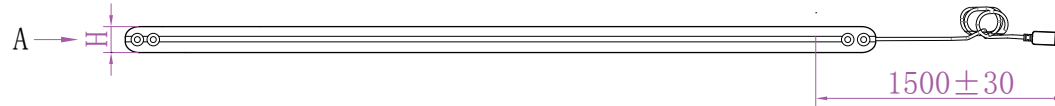

C

S(Inch/mm)	47.78"/1213.62
W1	599.9(+1/-0)
W2	639.5(+1/-0)
L1	1054.2(+1/-0)
L2	1093.8(+1/-0)
H	11.4 ±0.2



Anti-Sunlight, No Blind Zone For Any Size



D

Material:	plastic	Unit:	mm	Date:		Rev:	1.0
Draft by:		Approved by:					

4

3

2

1