

4

3

2

1

A

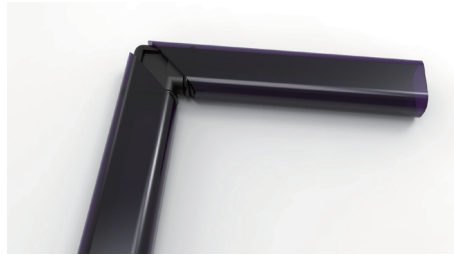

B

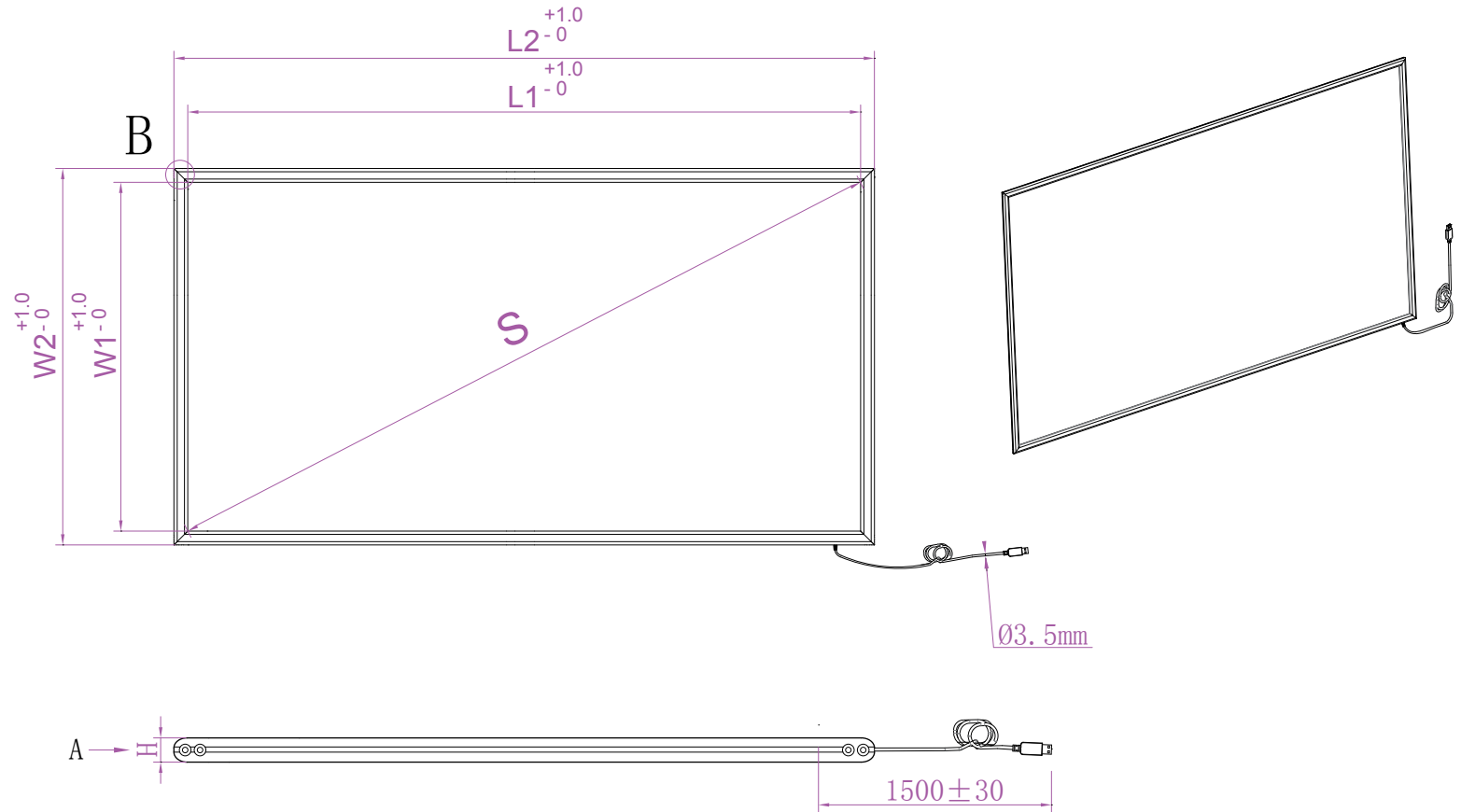

A

B

C

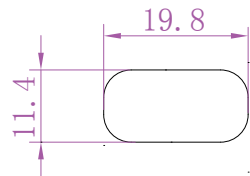

A

C

S(Inch/mm)	72.73"/1847.40
W1	906.7(+1/-0)
W2	946.3(+1/-0)
L1	1608.8(+1/-0)
L2	1648.4(+1/-0)
H	11.4 ±0.2



Anti-Sunlight, No Blind Zone For Any Size



D

Material:	plastic	Unit:	mm	Date:		Rev:	1.0
Draft by:		Approved by:					

4

3

2

1