

4

3

2

1

A

B

C

D

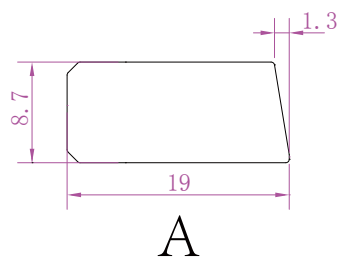
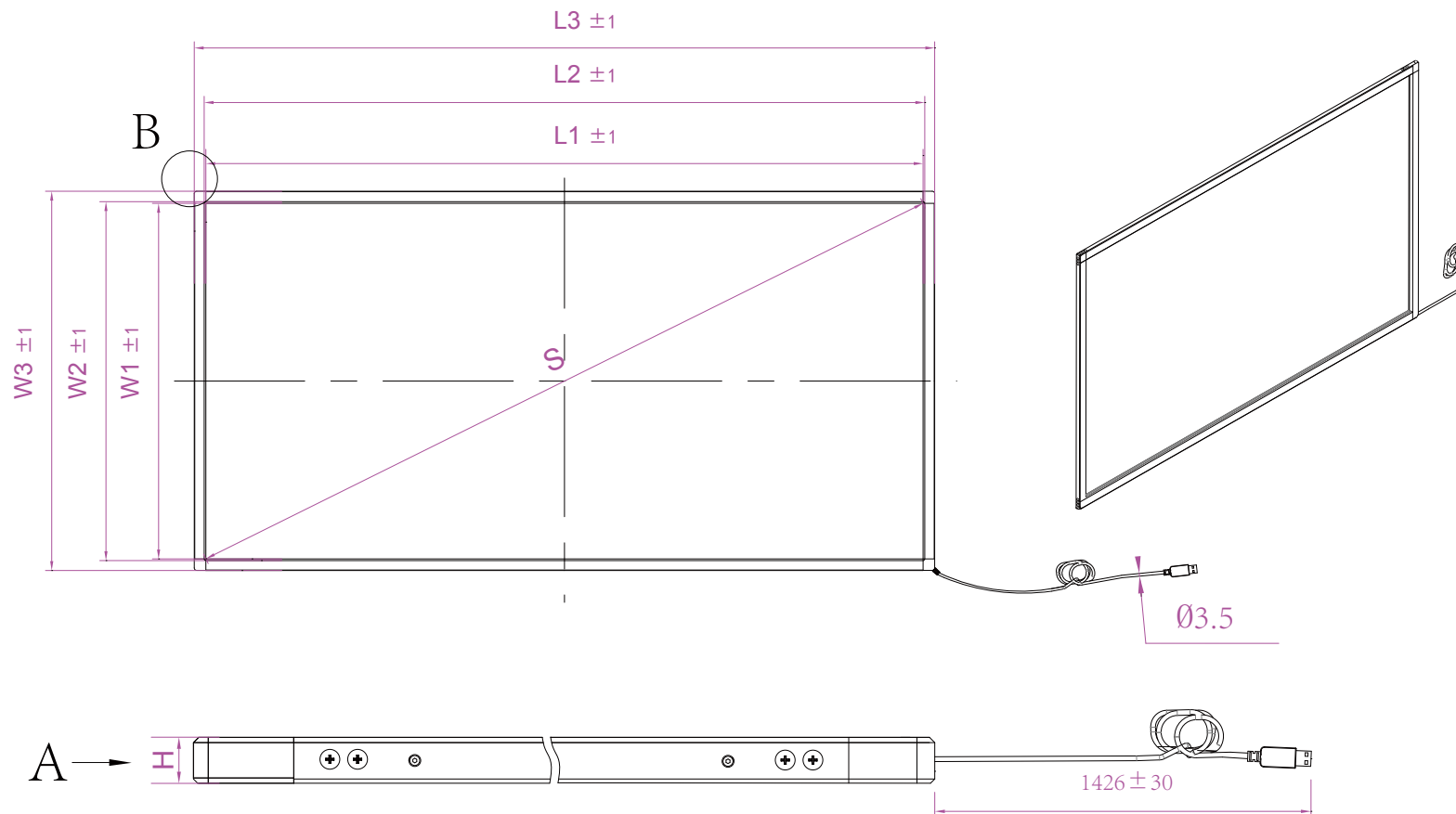
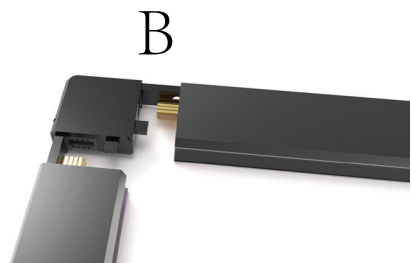

A

H

1426 ± 30

Ø3.5

S(Inch/mm)	42.17"/1071.28
W1	526.1 ± 1
W2	528.7 ± 1
W3	564.1 ± 1
L1	933.2 ± 1
L2	935.8 ± 1
L3	971.2 ± 1
H	8.7 ± 0.2



Anti-Sunlight, No Blind Zone For Any Size



X Slim Series

Material:	aluminum	Unit:	mm	Date:		Rev:	1.0
Draft by:		Approved by:					

4

3

2

1