

PT002721

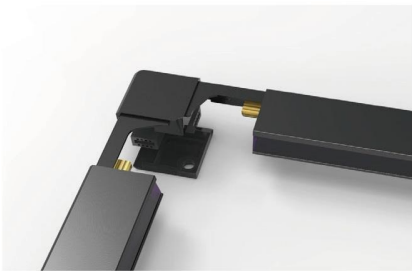

B

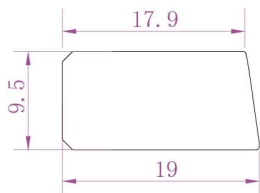
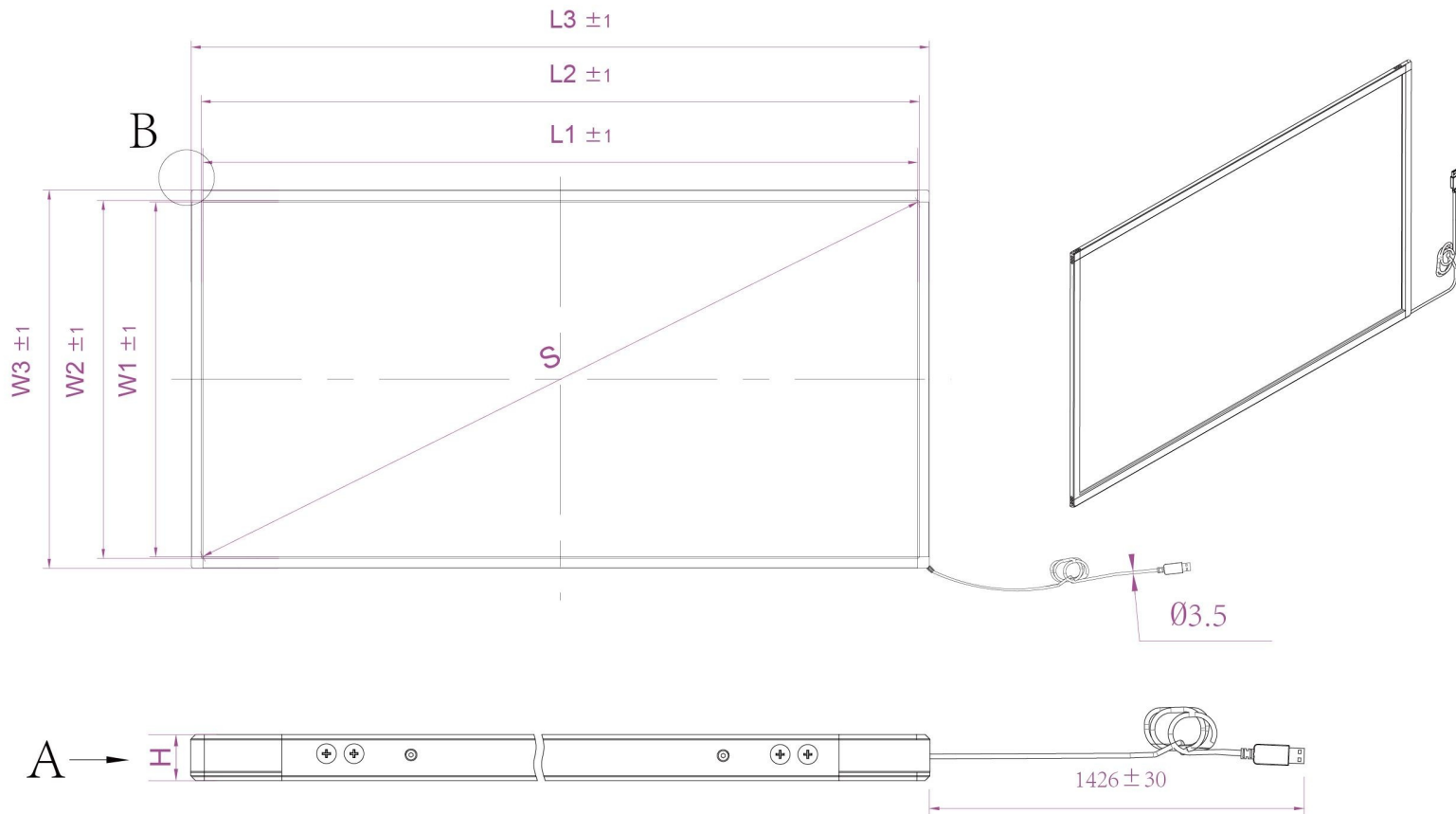

A

S(Inch/mm)	56.59"/1437.28
W1	708.0±1
W2	710.2±1
W3	746.0±1
L1	1250.8±1
L2	1253.0±1
L3	1288.8±1
H	9.5±0.2



Anti-Sunlight, No Blind Zone For Any Size

X Slim Series						
Material	aluminum	Unit	mm	Date	2018-11-14	Memo
Draft:		Accepted:		Approved:		

