

4

3

2

1

A

B

C

D

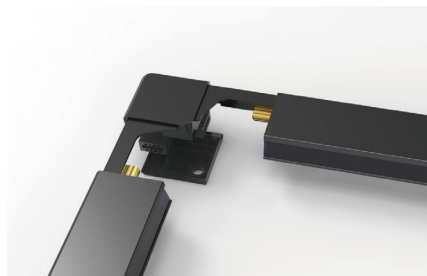

B

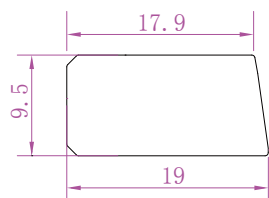
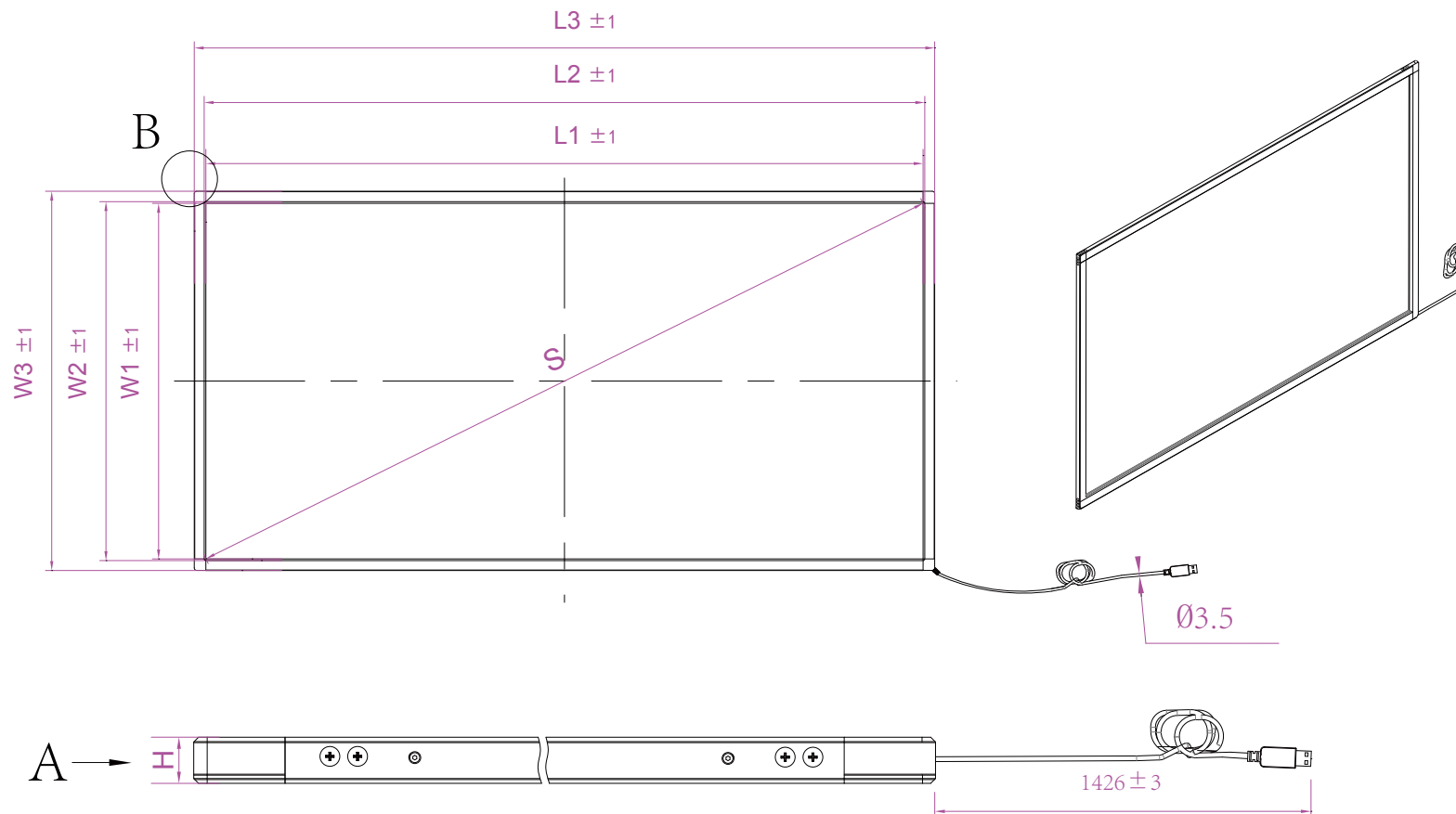

A

A

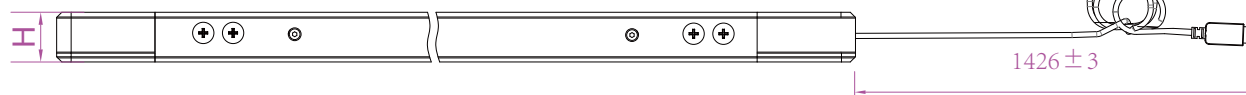

S(Inch/mm)	97.58"/2478.62
W1	1215.9 ± 1
W2	1218.1 ± 1
W3	1253.9 ± 1
L1	2159.9 ± 1
L2	2162.1 ± 1
L3	2197.9 ± 1
H	9.5 ± 0.2



Anti-Sunlight, No Blind Zone For Any Size



X Slim Series

Material:	aluminum	Unit:	mm	Date:		Rev:	1.0
Draft by:		Approved by:					

4

3

2

1