

4

3

2

1

A

B

C

D

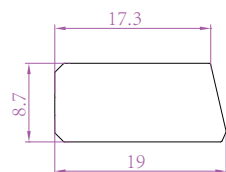
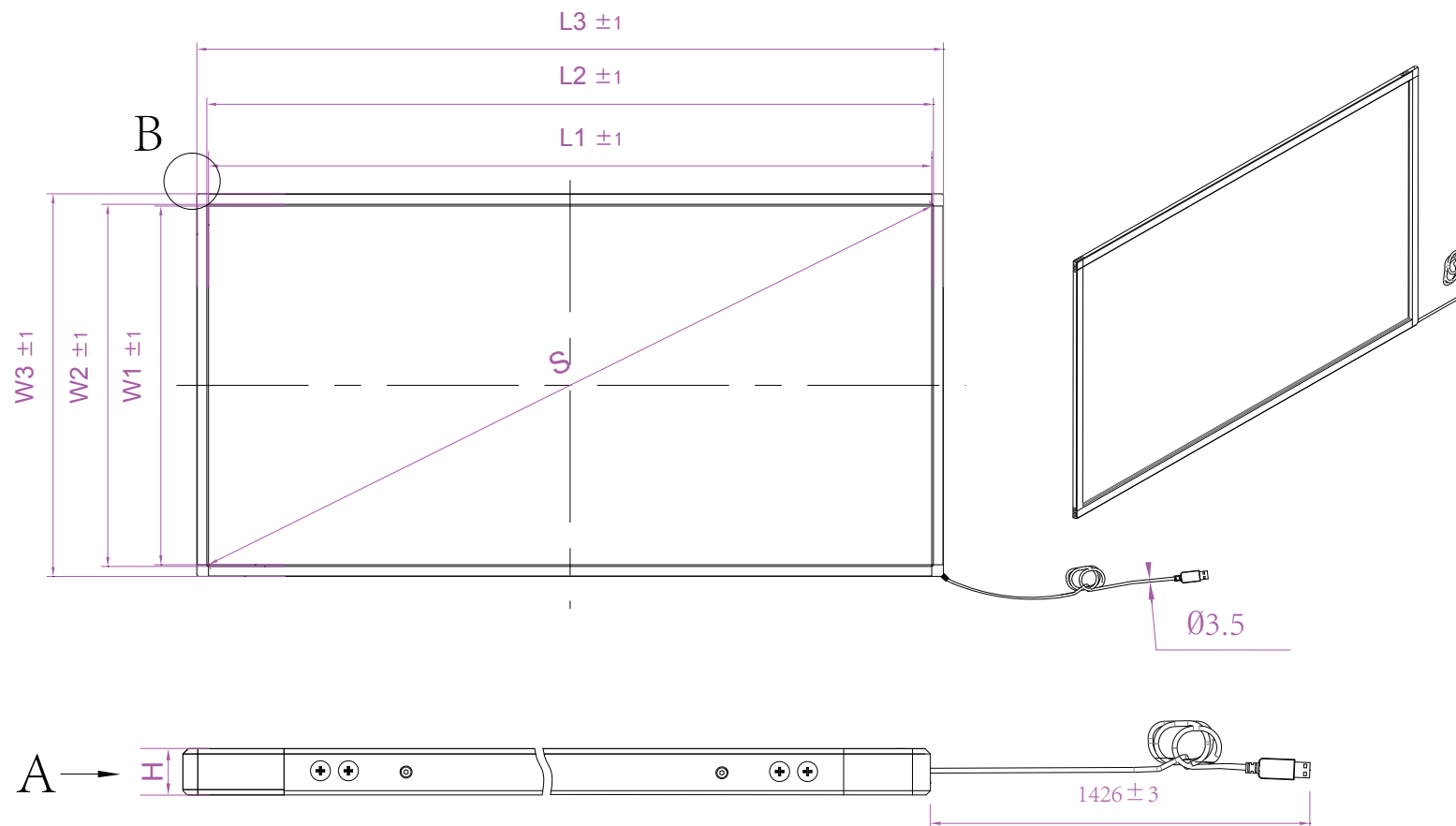
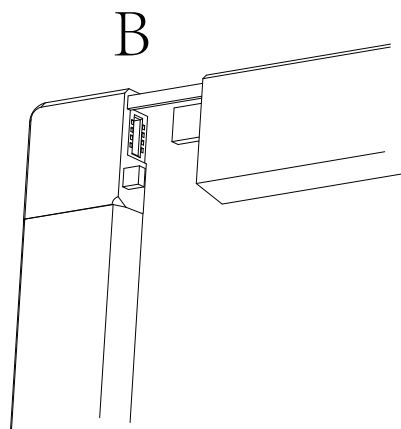

A

S(Inch/mm)	26.16"/664.40
W1	325.5 ± 1
W2	328.9 ± 1
W3	363.5 ± 1
L1	579.2 ± 1
L2	582.6 ± 1
L3	617.2 ± 1
H	8.7 ± 0.2



Anti-Sunlight, No Blind Zone For Any Size



X Slim Series							
Material:	plastic	Unit:	mm	Date:		Rev:	1.0
Draft by:				Approved by:			

4

3

2

1