

4

3

2

1

A

B

C

D

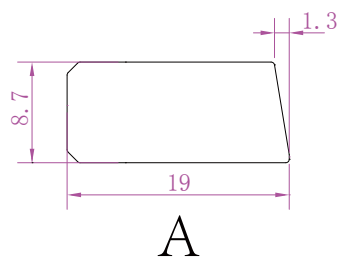
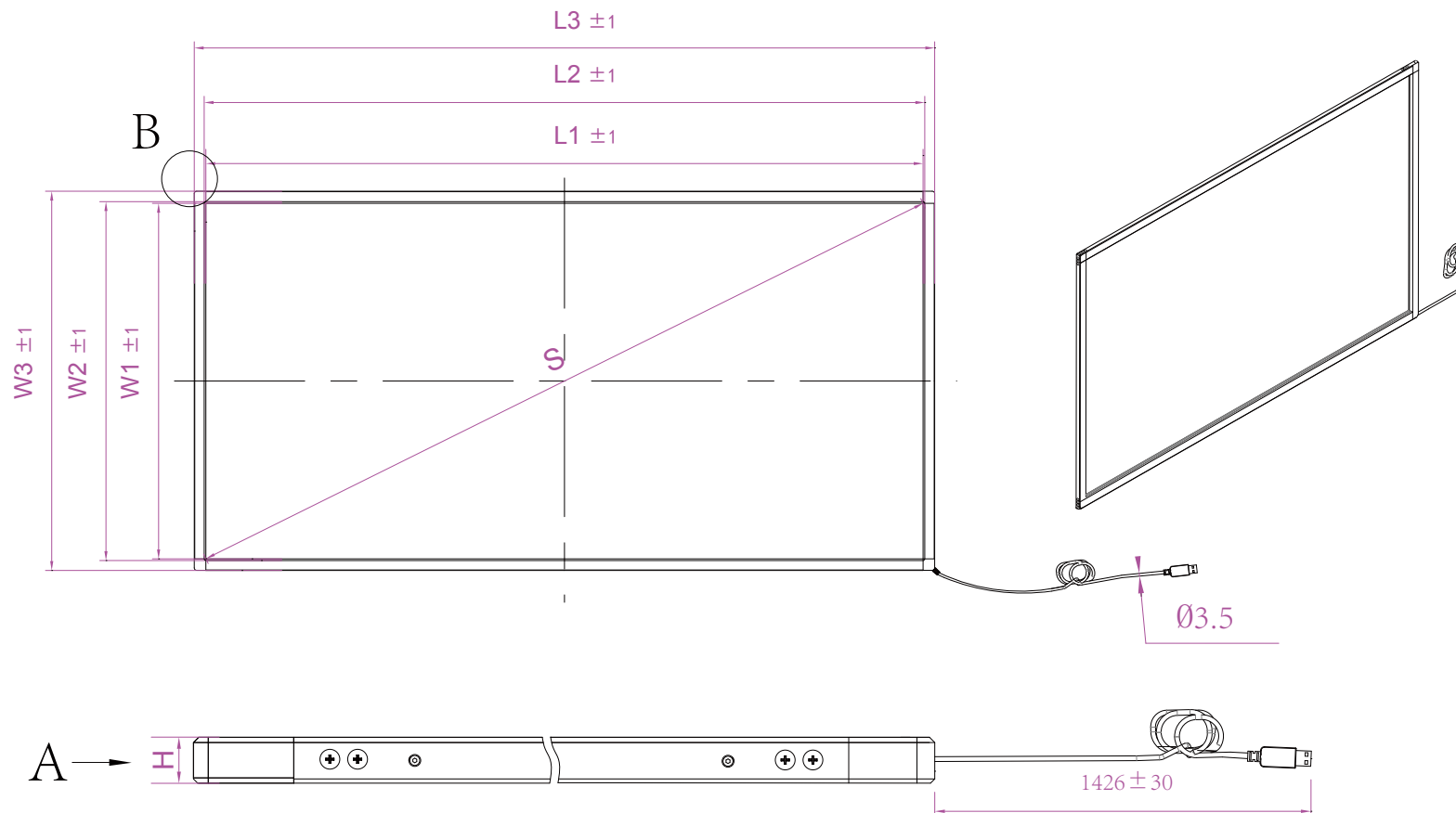
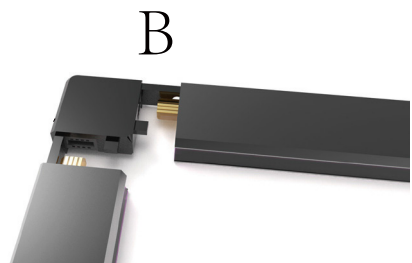

S(Inch/mm)	46.10"/1170.88
W1	572.8 ± 1
W2	575.4 ± 1
W3	610.8 ± 1
L1	1021.2 ± 1
L2	1023.8 ± 1
L3	1059.2 ± 1
H	8.7 ± 0.2



Anti-Sunlight, No Blind Zone For Any Size



X Slim Series							
Material:	aluminum	Unit:	mm	Date:		Rev:	1.0
Draft by:				Approved by:			

4

3

2

1