

4

3

2

1

A

B

C

D

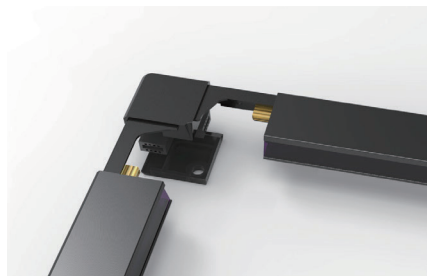

B

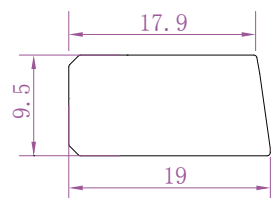
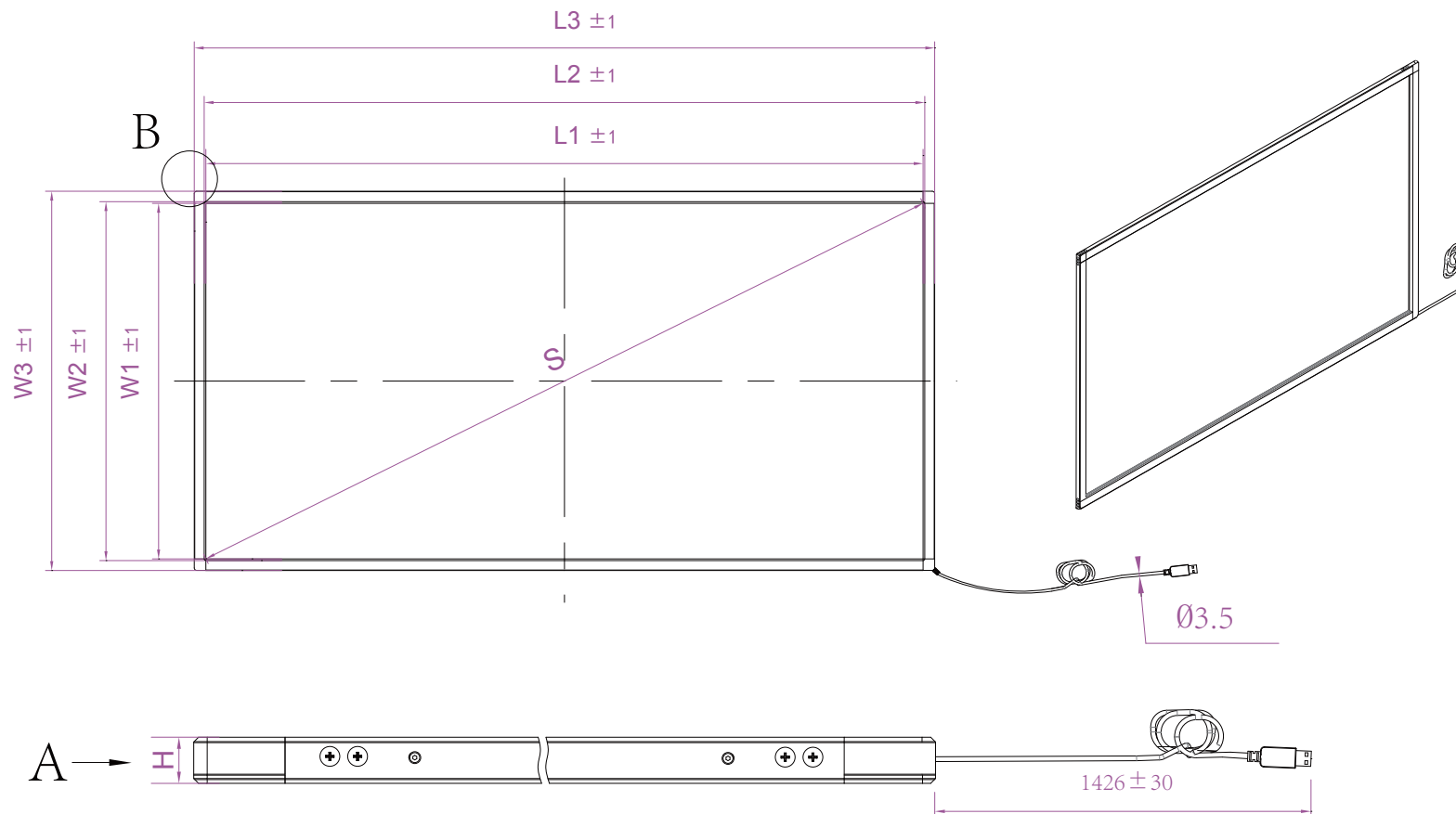

A

A

S(Inch/mm)	64.82"/1646.54
W1	808.8 ± 1
W2	811.0 ± 1
W3	846.8 ± 1
L1	1434.2 ± 1
L2	1436.4 ± 1
L3	1472.2 ± 1
H	9.5 ± 0.2



Anti-Sunlight, No Blind Zone For Any Size



X Slim Series							
Material:	aluminum	Unit:	mm	Date:		Rev:	1.0
Draft by:				Approved by:			

4

3

2

1